

# 5MP HD Intelligent Light and Audible Warning Fixed Eyeball Network Camera

IPC3615SB-ADF28(40)KMC-I0



## Key Features



- High quality image with 5MP, 1/2.7"CMOS sensor
- 5MP (2880\*1620)@ 30/25fps; 4MP (2560\*1440)@ 30/25fps; 3MP (2304\*1296) @30/25fps; 2MP (1920\*1080) @30/25fps
- Ultra 265, H.265, H.264, MJPEG
- Smart intrusion prevention, include cross line, intrusion, enter area, leave area detection
- Based on target classification, smart intrusion prevention significantly reduce false alarm caused by leaves, birds and lights etc., accurately focus on human and, motor vehicle and non-motor vehicle
- Supports sound and light alarm linkage.When Smart intrusion prevention is triggered , the camera links sound alarm and light linkage.
- Intelligent People Flow Counting and Crowd Density Monitoring
- 120dB true WDR technology enables clear image in strong light scene
- Support 9:16 Corridor Mode
- Built-in Mic and Speaker
- Smart IR, up to 30m (98ft) IR distance
- Supports 256 G Micro SD card
- IP67 protection
- Support PoE power supply

## Specifications

	IPC3615SB-ADF28KMC-10	IPC3615SB-ADF40KMC-10			
<b>Camera</b>					
Sensor	1/2.7", 5.0 megapixel, progressive scan, CMOS				
Minimum Illumination	Colour: 0.002 lux (F1.6, AGC ON) 0 lux with IR on				
Day/Night	IR-cut filter with auto switch (ICR)				
Shutter	Auto/Manual, 1 ~ 1/100000s				
Adjustment angle	Pan: 0° ~ 360°	Tilt: 0° ~ 80°	Rotate: 0° ~ 360°		
WDR	120dB				
S/N	>56dB				
<b>Lens</b>					
Lens type	2.8mm@F1.6	4.0mm@F1.6			
Iris	Fixed				
Field of View (H)	112.9°	91.2°			
Field of View (V)	59.1°	47.9°			
Field of View (D)	121.2°	95.9°			
<b>DORI</b>					
DORI Distance	Lens (mm)	Detect (m)	Observe (m)	Recognize (m)	Identify (m)
	2.8	63.0	25.2	12.6	6.3
	4.0	90.0	36.0	18.0	9.0
<b>Illuminator</b>					
Illumination Distance(IR)	Up to 30m (98 ft)				
Illumination Distance(Warm Light)	Up to 30m (98 ft)				
Wavelength	850nm				
IR On/Off Control	Auto/Manual				
<b>Video</b>					
Video Compression	Ultra 265, H.265, H.264, MJPEG				
H.264 code profile	Baseline profile, Main profile, High profile				
Frame Rate	Main Stream:5MP (2880*1620), Max 30fps; 4MP (2560*1440), Max 30fps; 3MP (2304*1296), Max 30fps; 1080P (1920*1080), Max 30fps; Sub Stream: 720P (1280*720), Max 30fps; D1 (720*576), Max 30fps; 640*360,Max 30fps; Third Stream: D1 (720*576), Max 30fps; 640*360,Max 30fps; 2CIF(704*288), Max 30fps; CIF(352*288), Max 30fps;				
Video Bit Rate	128 Kbps~16 Mbps				
U-code	Support				
OSD	Up to 8 OSDs				
Privacy Mask	Up to 4 areas				
ROI	Up to 8 areas				
Video Stream	Triple streams				
<b>Image</b>					
White Balance	Auto/Outdoor/Fine Tune/Sodium Lamp/Locked/Auto2				
Digital Noise Reduction	2D/3D DNR				
Smart IR	Support				

Flip	Normal/Vertical/Horizontal/180°/90°Clockwise/90°Anti-clockwise
Dewarping	N/A
HLC	Supported
BLC	Supported
Defog	Digital Defog
<b>Intelligent</b>	
Smart intrusion prevention	Support false alarm filtering: Cross Line detection, Intrusion detection, Enter Area detection, Leave Area detection
Statistical Analysis	People counting, support people flow counting and crowd density monitoring
<b>Events</b>	
Basic Detection	Motion detection, tampering alarm, audio detection
General Function	Watermark, IP address filtering, access policy, ARP protection, RTSP authentication, user authentication
<b>Audio</b>	
Audio Compression	G.711
Audio Bitrate	64 Kbps
Two-way audio	Supported
Suppression	Supported
Sampling Rate	8KHZ
<b>Storage</b>	
Edge Storage	Micro SD, up to 256 GB
Network Storage	ANR, NAS(NFS)
<b>Network</b>	
Protocols	IPv4, IGMP, ICMP, ARP, TCP, UDP, DHCP, PPPoE, RTP, RTSP, RTCP, DNS, DDNS, NTP, FTP, UPnP, HTTP, HTTPS, SMTP, 802.1x, SNMP, QoS, RTMP,SSL/TLS, SSH
Compatible Integration	ONVIF (Profile S, Profile G, Profile T) , API,SDK
User/Host	Up to 32 users. 2 user levels: administrator and common user
Security	Password protection, Strong password, HTTPS encryption, Export operation logs, Basic and digest authentication for RTSP, Digest authentication for HTTP, TLS 1.2, WSSE and digest authentication for ONVIF
Client	EZStation EZView EZLive
Web Browser	Plug-in required live view: IE9+, Chrome 41 and below, Firefox 52 and below
	Plug-in free live view: Chrome 57.0+, Firefox 58.0+, Edge 16+
<b>Interface</b>	
Audio I/O	N/A
Alarm I/O	N/A
RS485	N/A
Built-in Mic	Support
Built-in Speaker	Support
WIFI	N/A
Network	1 * RJ45 10M/100M Base-TX Ethernet
Video Output	N/A
<b>Certifications</b>	
EMC	CE-EMC (EN 55032: 2015+A1:2020,EN 61000-3-3: 2013+A1: 2019,EN IEC 61000-3-2: 2019+A1: 2021,EN 55035: 2017+A11:2020) FCC (FCC CFR 47 part15 B, ANSI C63.4-2014)
Safety	CE LVD (EN 62368-1:2014+A11:2017)

	CB (IEC 62368-1:2014) UL (UL 62368-1, 2nd Ed., Issue Date: 2014-12-01)
Environment	CE-RoHS (2011/65/EU;(EU)2015/863); WEEE (2012/19/EU); Reach (Regulation (EC) No 1907/2006)
Protection	IP67 (IEC 60529:1989+AMD1:1999+AMD2:2013)
<b>General</b>	
Power	DC 12V±25%, PoE (IEEE 802.3af)
	Power consumption: Max 7.5W
Power Interface	Ø 5.5mm coaxial power plug
Dimensions (Ø x H)	Φ111 x 95mm (Φ4.4" x 3.7")
Weight	0.44kg (0.970lb)
Material	Metal + Plastic
Working Environment	-30°C ~ 55°C (-22°F ~ 131°F), Humidity: ≤95% RH (non-condensing)
Storage Environment	-30°C ~ 55°C (-22°F ~ 131°F), Humidity: ≤95% RH (non-condensing)
Surge Protection	4KV
Reset Button	N/A

## Dimensions

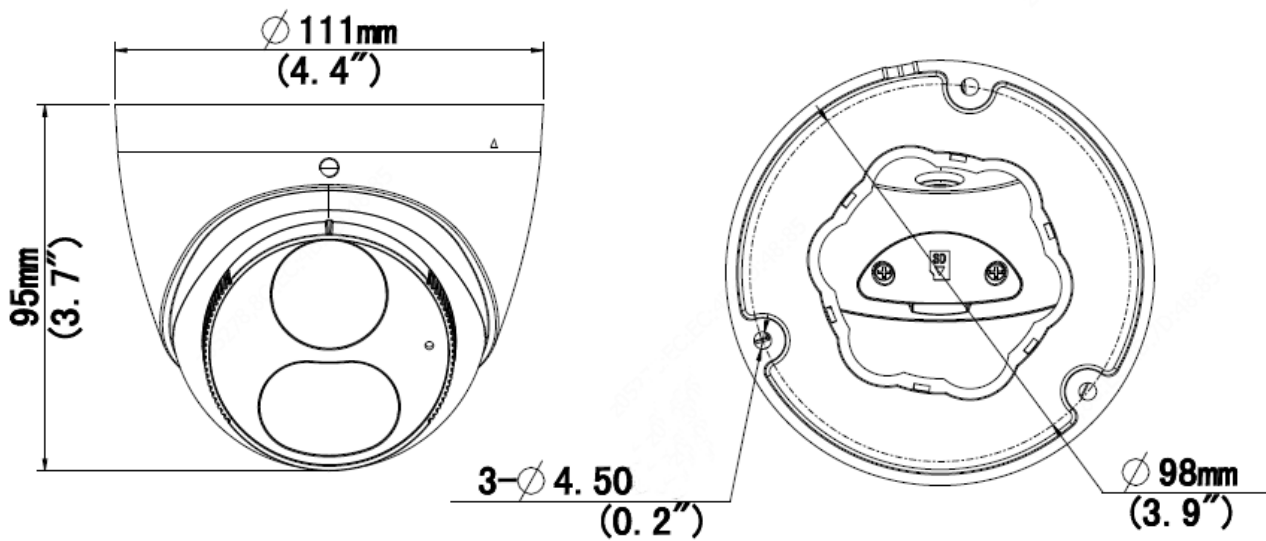

## Accessories

TR-JB03-G-IN

Junction Box



TR-JB07/WM03-G-IN

Wall Mount

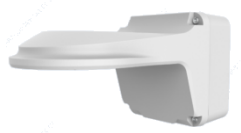

TR-WM03-D-IN

Wall Mount

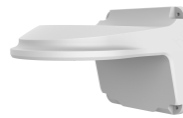

TR-UM06-E-IN

Incline Ceiling Mount



TR-UP06-IN

Pole Mount



TR-A01-IN

Waterproof Joint



TR-SE24-IN

Pendant Mount



TR-SE24-A-IN

Pendant Mount



TR-CM24-IN

Pendant Mount

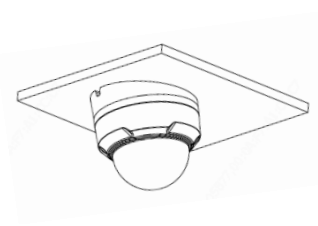
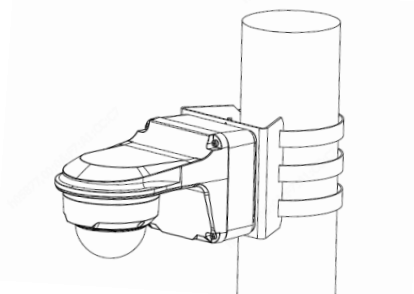
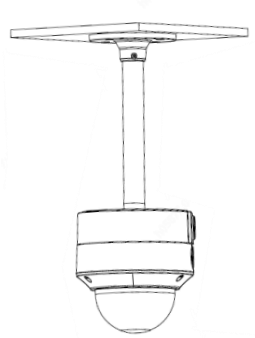

Junction Mount	Pole Mount
TR-JB03-G-IN	TR-JB07/WM03-G-IN

TR-UM06-E-IN	TR-JB07/WM03-G-IN+TR-UP06-IN
	
TR-CM24-IN+TR-JB03-G-IN	
	

**Zhejiang Uniview Technologies Co., Ltd.**

Building No.10, Wanlun Science Park, Jiangling Road 88, Binjiang District, Hangzhou, Zhejiang, China (310051)

Email: [overseasbusiness@uniview.com](mailto:overseasbusiness@uniview.com); [globalsupport@uniview.com](mailto:globalsupport@uniview.com)

<http://www.uniview.com>

©2021 Zhejiang Uniview Technologies Co., Ltd. All rights reserved.

\*Product specifications and availability are subject to change without notice.